



[www.my-ray.com](http://www.my-ray.com)



**BU Medical Equipment**

**Plant** - Via Bicocca, 14/c - 40026 Imola - Bo (Italy) tel. +39 0542 653441 - fax +39 0542 653555

**Headquarters** - Cefla s.c. Via Selice Provinciale, 23/a - 40026 Imola - Bo (Italy) tel. +39 0542 653111 - fax +39 0542 653344

**Cefla North America**, Inc. 6125 Harris Technology Blvd. Charlotte, NC 28269 - U.S.A. Toll Free: (+1) 800.416.3078 Fax: (+1) 704.631.4609

Data subject to changes without prior notice. 03/2023 MDCSGB221500  
According to the regulations in force, some products and/or features may have different availability and characteristics in areas outside of the European Union. Please contact your local distributor.



**Zen-X DCiS**  
DC Wireless intraoral sensor



# As simple as freedom!

The first intraoral sensor with Wire Free system and DC (Direct Conversion), for accurate X-ray imaging in just a few steps.

Cordless for maximum usability.

Compact and ergonomic for patient comfort.

**Wire Free. To be free.**



IP67 certified for protection against liquids and dust.

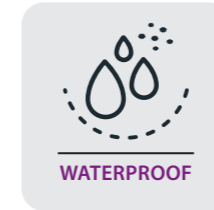

**COMPACT**

Less stress for the patient with rounded edges. Minimum thickness thanks to Direct Conversion (DC) technology which streamlines the number of internal components. Extremely slim rechargeable lithium battery housing hub.

**PRACTICAL**

Status LED on the back. Size 2 with large active area for generation of the X-ray image.

**ALL IN ONE**

Docking station for housing and charging the sensor when not in use.



**WIRE FREE**

Antenna for data reception in Wireless mode: minimum consumption, maximum image yield.

**WHEREVER YOU WANT**

Place your docking station on a work surface, on your desk or on the wall using the special fixing kit. Status LED always visible. Simple and always accessible USB connection.

# Efficient and patient-friendly.

Enhance your workflow and patient experience with Zen-X DCiS. The right tool to get the most out of your time.

Experience the convenience of our Wire Free system: no cables to hinder movements; no stress for the patient thanks to the sensor low thickness and rounded corners; accessories to facilitate positioning while minimising discomfort for the patient.

Since the cable is the part most exposed to wear, the Wire Free system also guarantees a longer sensor life.

Zen-X DCiS, integrating direct conversion technology, has no internal easily breakable components and is therefore more resistant to falls and impacts.

**Simply the best.**

- Compact and minimally invasive
- Cordless
- Easy positioning



## DESIGNED TO LAST

Stronger outer shell and internal components for increased impact and compression resistance and a longer life. No fragile components such as the scintillator which is required in sensors that do not integrate DC technology.



## COMFORT

Non-invasive sensor thanks to its extremely low thickness and smooth lines without edges. Zen-X DCiS puts patient health and care first.

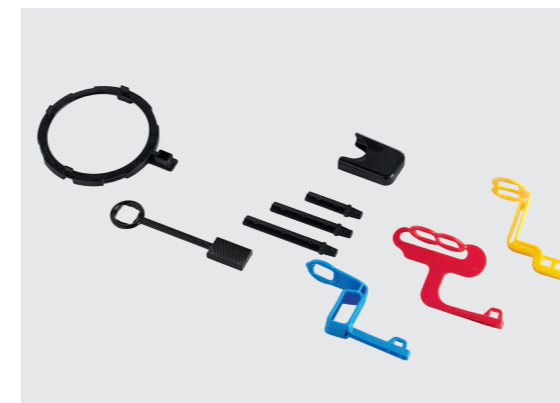

## POSITIONING

Alignment system created specifically for Zen-X DCiS that does not add extra bulk to the sensor profile and guarantees superior patient comfort.

Easy to position, it allows the X-ray unit to be brought closer to the patient face exposing only the required areas - thanks to a special alignment ring and positioners designed to adapt perfectly to specific diagnostic needs.

# The ultimate 2D imaging.

First wireless direct conversion sensor. Zen-X DCiS incorporates all the best high-tech imaging technologies.

Zen-X DCiS integrates direct conversion technology, which does not require the conversion of X-rays into visible light. Fewer steps, fewer components, smaller footprint and above all - perfect image quality. Once scanning is complete, iRYS will take care of everything.

MyRay's native software features advanced filters to further enhance the image or emphasize details.

**Less is more.**

- Fewer required steps
- More sharpness
- Better contrast
- Minimal bulk
- Long life



### MultiIMAGE

This original MyRay function is designed to meet the real needs of dentists like you. By using proprietary PiE (Powerful image Enhancer) algorithms optimised for the Zen-X DCiS sensor, this function lets dentists simultaneously capture, display and share a set of up to 5 images. Each image is the result of a different type of improvement designed to highlight various anatomical details with different levels of sharpness and contrast, ensuring dentists can diagnose better.

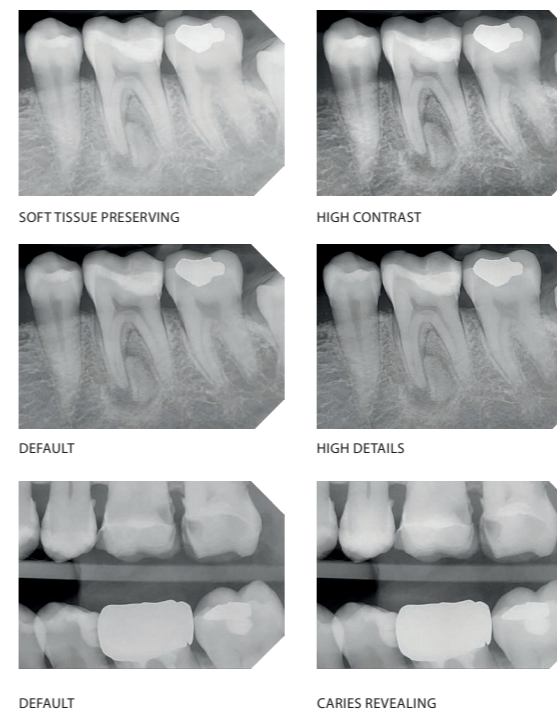

### PiE (Powerful Image Enhancer) FILTERS

New set of filters to highlight all the details necessary for different clinical requirements.

**Soft tissue preserving:** keeps areas at risk of image darkening unaltered to highlight soft tissues.

**High contrast:** enhances the contrast, if the image is low in contrast due to anatomical reasons or X-ray parameters.

**Default:** balances noise, contrast and sharpness.

**High details:** emphasizes image details.

**Caries revealing:** improves the contrast level of bitewing images allowing easier identification of interproximal caries.

### IN-DEPTH DETAIL

The best of 2D X-ray imaging: Zen-X DCiS direct conversion sensor produces sharper images with better contrast than a conventional sensor.

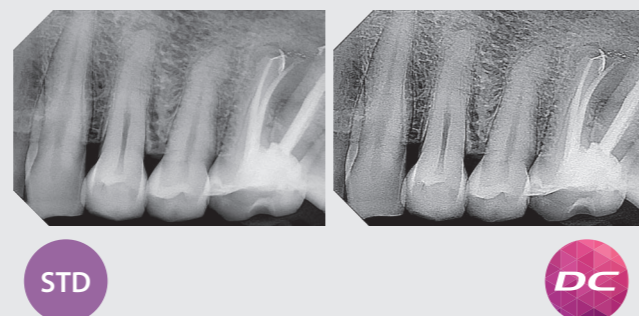

### THE BENEFITS OF DIRECT CONVERSION

With a standard sensor X-rays have to be converted into visible light, using a scintillator, because the sensor reacts to light like a photographic film. Zen-X DCiS, on the other hand, is a direct conversion sensor: it receives and processes X-rays directly. Fewer steps mean a lower risk of diagnostic information loss, sharper and well-contrasted images, even at low doses.

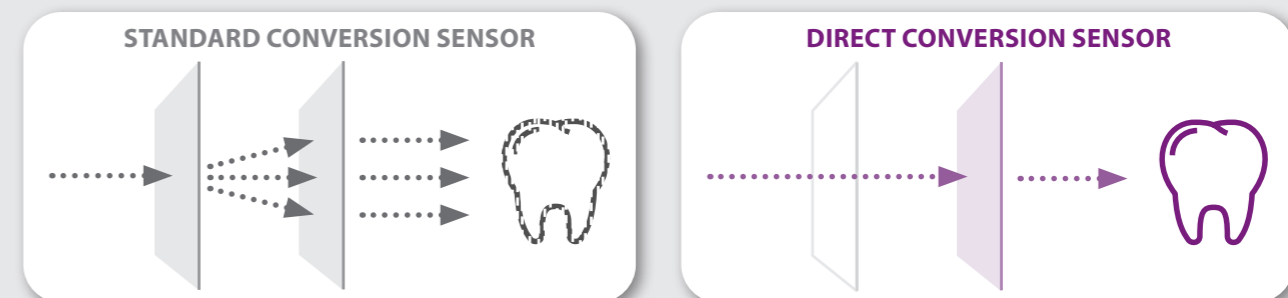

# Your best workflow solution.

Choose the configuration that best suits your needs. The sensor adapts to your work, not the other way around.

Zen-X DCiS streamlines your workflow and integrates seamlessly into your clinic. Through Wireless technology, the sensor interacts with the docking station wirelessly and with minimum power consumption with no impact on quality.

In just a few seconds the image is available on the monitor to be shared with the patient and colleagues.

With iRYS you can browse through images, calibrate them or use pre-settable filters.

The software allows pairing with the dentition chart and has predefined layouts to quickly store and view the X-rays.

A preferred combination of sensors and docking station can also be chosen.

Zen-X DCiS is made to look like you!

**It fits!**

- Images available immediately
- Several possible configurations
- Energy saving

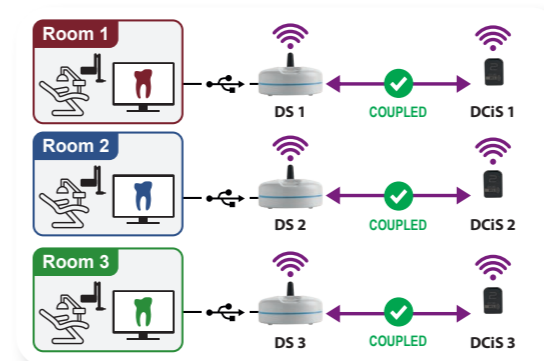
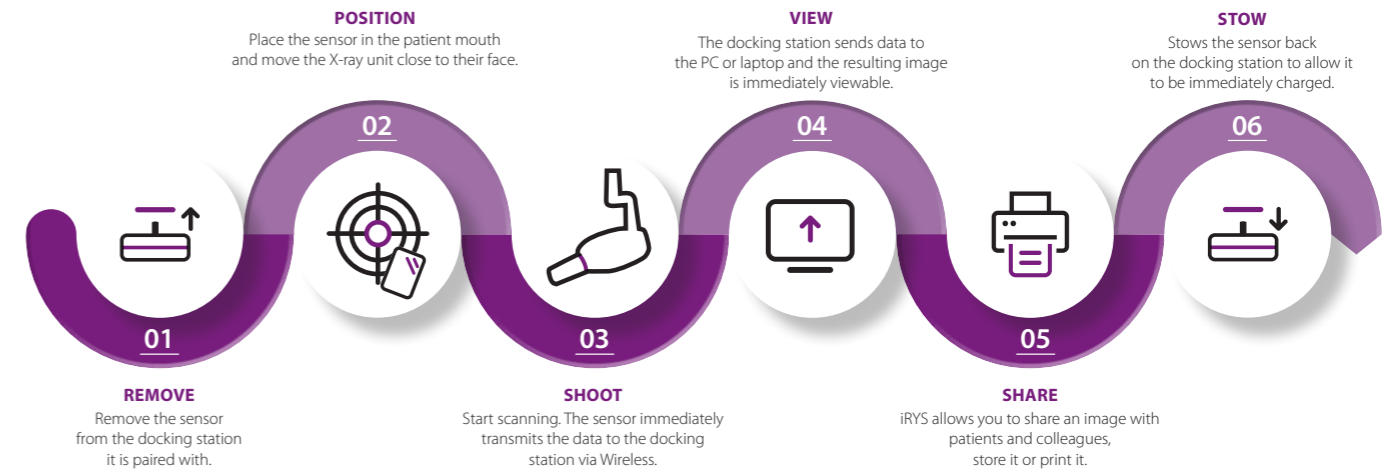

### WORKFLOW A

#### 1 to 1 pairing.

Each sensor interacts with its own docking station. Simultaneous data transmission is also possible.

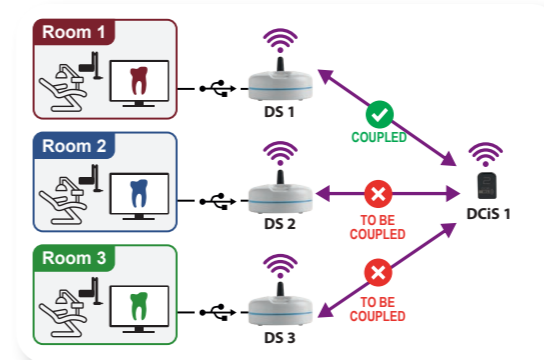

### WORKFLOW B

#### 1 to many pairing.

A single sensor interacts with multiple docking stations. The sensor can interact with only one docking station at a time.

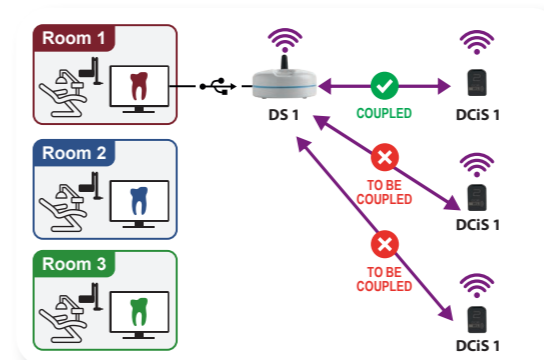

### WORKFLOW C

#### Many to 1 pairing.

Several sensors interact with a single docking station. Transmission can occur from only one sensor at a time.

# Optional accessories.

Add the alignment system designed for Zen-X DCiS.  
Choose where to keep the docking station.  
Optimized ergonomics and maximum user-friendliness.

Alignment system that facilitates positioning.  
No extra bulk for the sensor profile which is therefore minimally invasive in the patient's mouth for superior comfort.  
The system allows the X-ray unit to be brought closer to the patient's face, focussing the X-ray emission only on the area to be examined.  
A special kit allows you to install the docking station on the wall, freeing up workspace.  
**It's that easy!**

- Minimally invasive in the mouth
- Easy positioning
- Optimal alignment
- Wall fixing of the docking station



# Technical specifications.

DIMENSIONS	
Sensor size	2
Sensor footprint	43.4 mm (height) x 29.5 mm (width)
Sensor thickness	5.2 mm (9.2 mm considering the battery housing hub)
Active area	35.1 mm x 24.7 mm
Docking station	100 mm (diameter) x 62 mm (height)
USB lead length	2 m (supplied to connect docking station to PC/laptop)
IMAGE ACQUISITION	
Pixel matrix	1350 x 950 (1,282,500 pixel)
Detector	Single-crystal direct-conversion silicon / CMOS
MTF (Modulation Transfer Function)	> 70% @ 5 lp/mm, > 40% @ 10 lp/mm
Exposure parameters	0.1-0.5 s, 60-70 kV, 6/8 mA, 20 cm (8") cone
Wireless image transmission time	Less than 10 s under optimal working conditions
SENSOR TECHNICAL SPECIFICATIONS	
Internal battery	Rechargeable lithium ion (capacity 19 mAH)
Degree of protection	IP 67 (Guaranteed against liquid or dust infiltration)
Integrated RAM memory	4 MB (maximum 1 preservable image)
Image transmission technology	Wireless
Wireless operating distance	Up to 2.5 m from docking station
Compatibility with X-ray generators	Wall-mounted or cart (both AC and DC): 2-15 mA and 50-75 kV. Portable: 2-10 mA and 50-75 kV.
Complete recharge time	3.5 h (allows acquisition of 140* consecutive images, with a 40 s pause between two examinations)
Minimum advisable recharge time	15 minutes (allows acquisition of 19* consecutive images, with a 40 s pause between two examinations)
SOFTWARE	
Acquisition software (for PC)	iCapture with dedicated filters for third party software
Image management software (for PC)	iRYS (complies with ISDP©10003:2020 as per EN ISO/IEC17065:2012 certificate number 2019003109-2)
Supported protocols	DICOM 3.0, TWAIN, VDDS
DICOM nodes	IHE compliant (Print; Storage Commitment, SR document; WorkList; MPPS; Query/Retrieve)
MINIMUM SYSTEM REQUISITES	
Supported operating systems	Microsoft® Windows® 10 (Professional 64 bit) and 11
Processor	6th generation Intel i5 or equivalent
RAM	At least 4 GB of RAM and 100 GB of space on hard disc
Display	Resolution of 1920x1080 pixel and 24bit RGB Full HD (high definition)
COMMUNICATION INTERFACES	
Docking station connection port	USB-C
PC/laptop connection port	USB-A
Power supply	+5V ± 10%
Input power	2,5 W

\* Values susceptible to a reduction in performance due to effective battery life (the battery must only be replaced by qualified technicians).

